

# MERCURIO

di A. Castellani

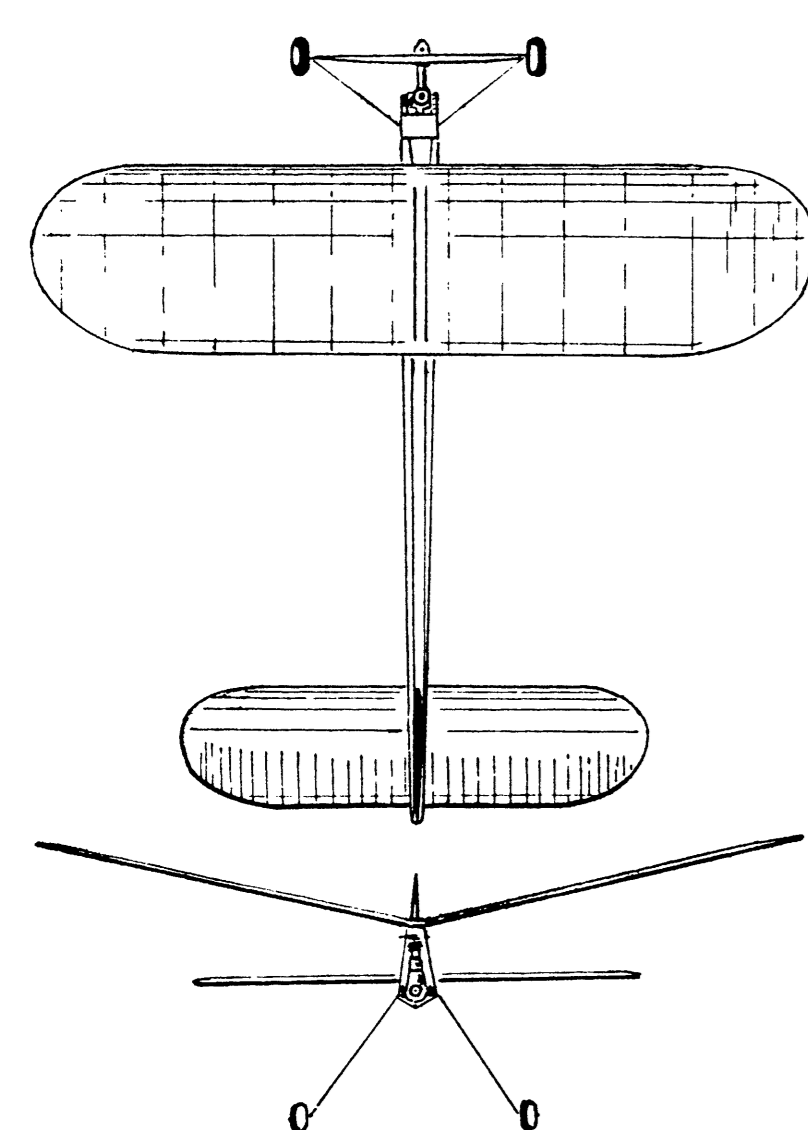

RIPRODUZIONE VIETATA

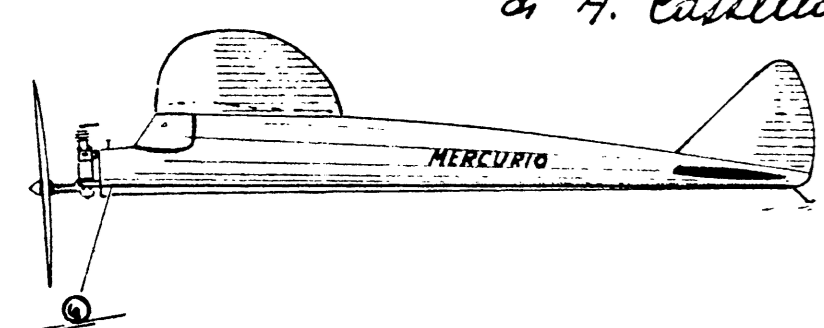
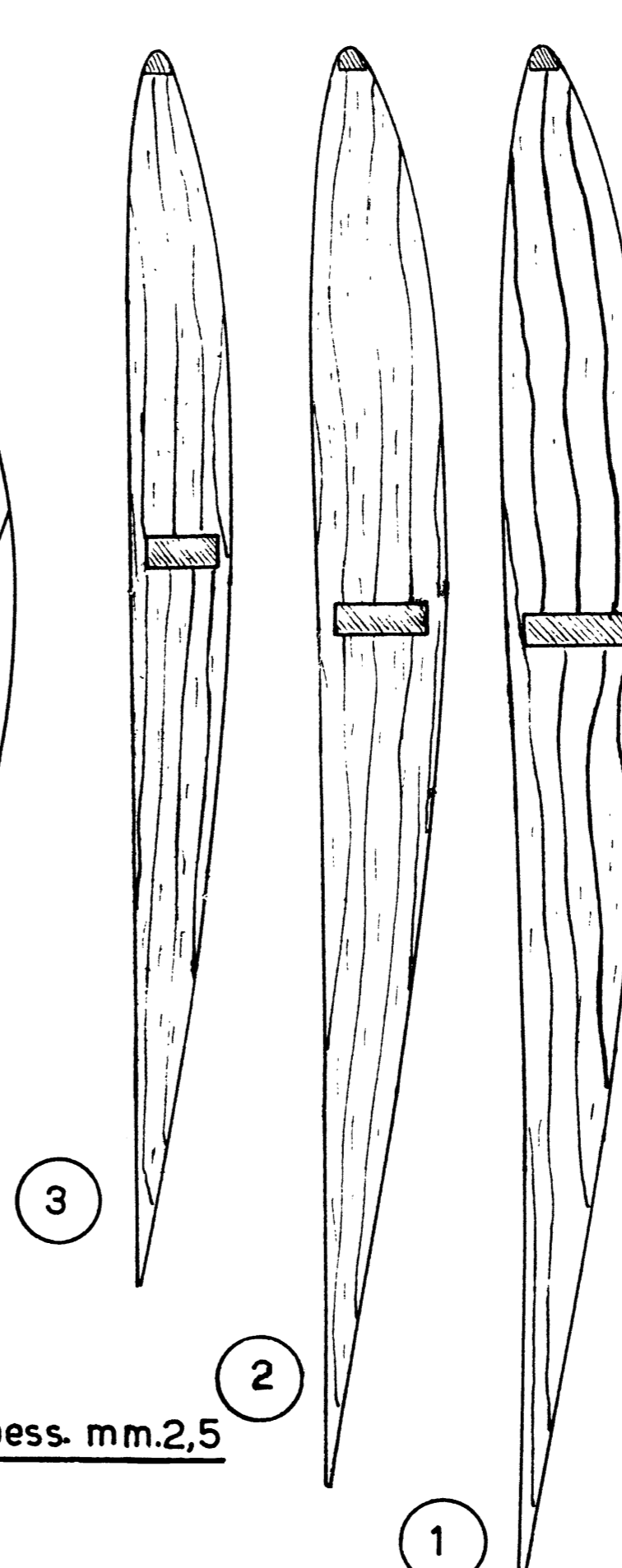
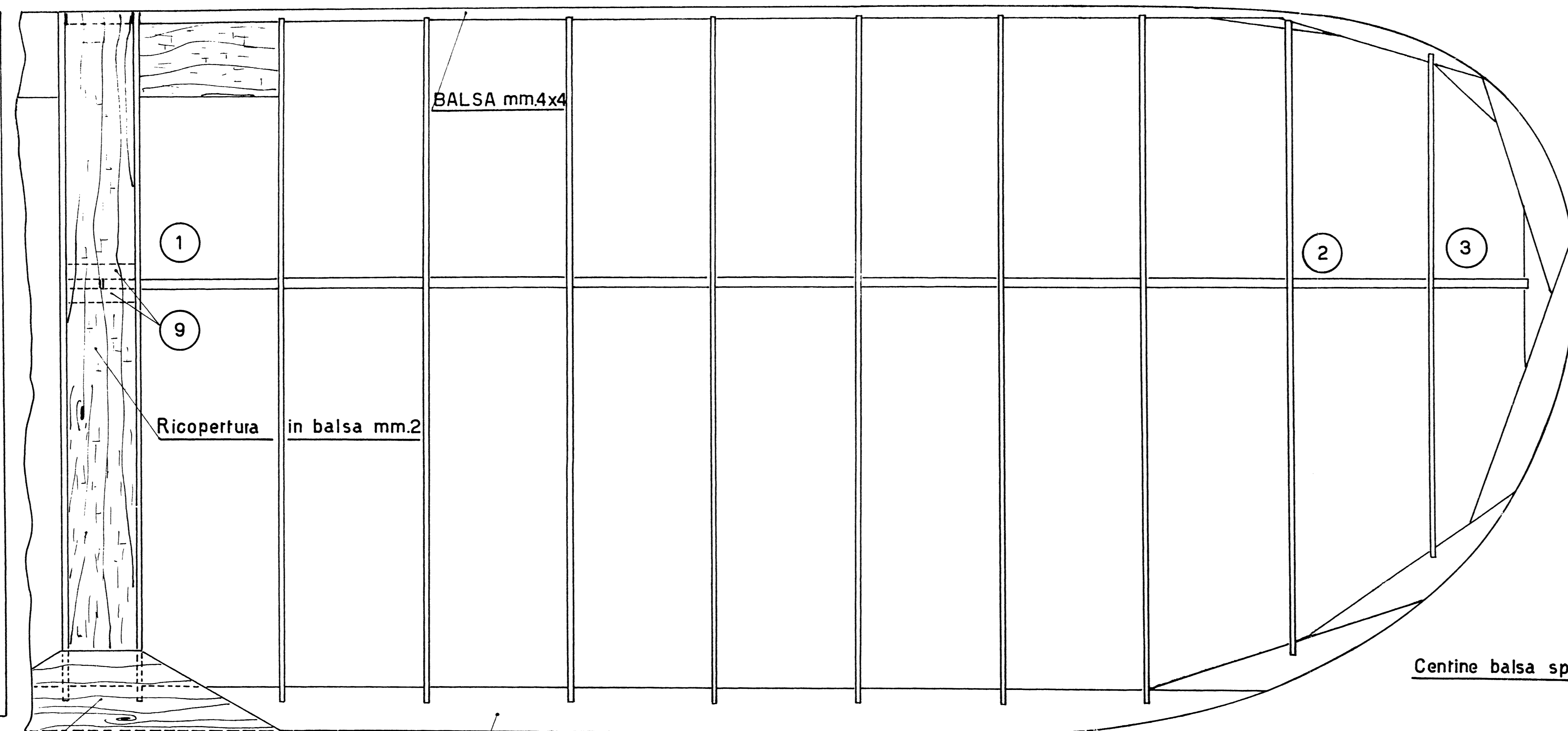

**ISTRUZIONI PER IL MONTAGGIO**

**ALA:** In unico pezzo-fissata alla fusoliera con legatura di elastici-ricoperta in carta

**FUSOLIERA:** Costruzione a traliccio-Unione delle due fiancate su piano di montaggio-Costola infer. fissata a fusoliera ultimata-Ricopertura in seta

**DERIVA:** Montata sulla fusoliera per mezzo pioli in spruce d $\varnothing$  mm. 3

**STABILIZZATORE:** Fissato con legatura di elastici

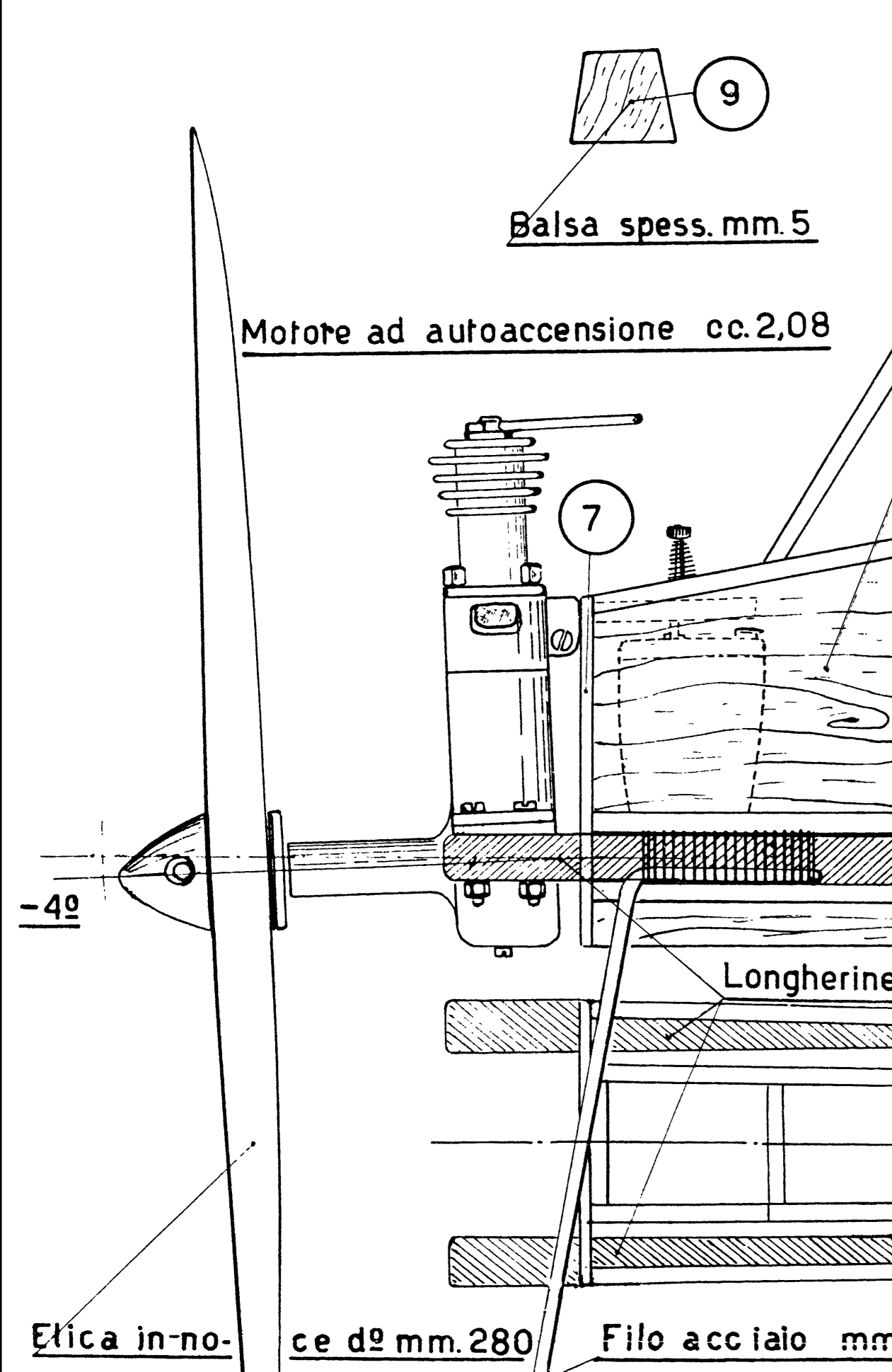
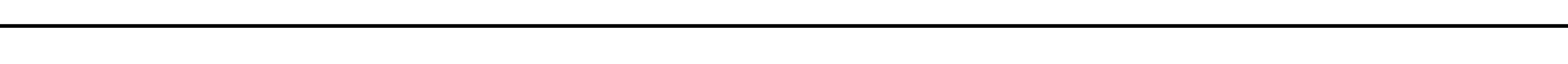
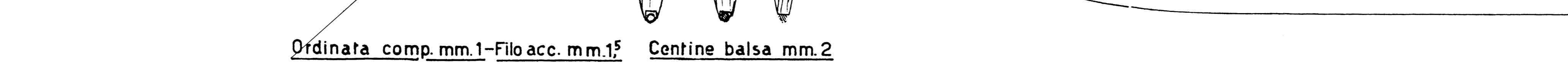
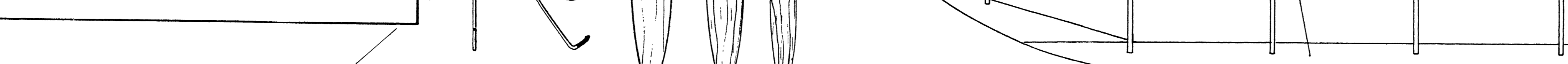
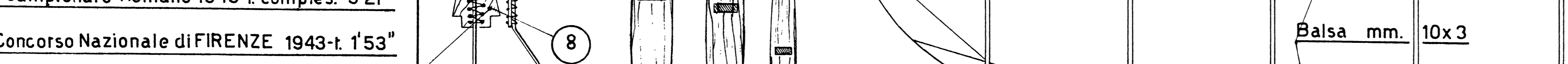
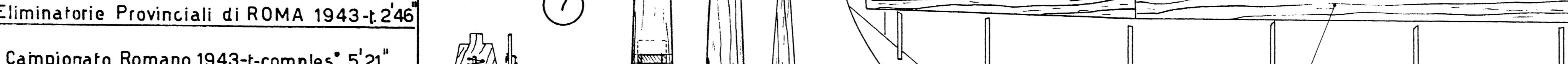
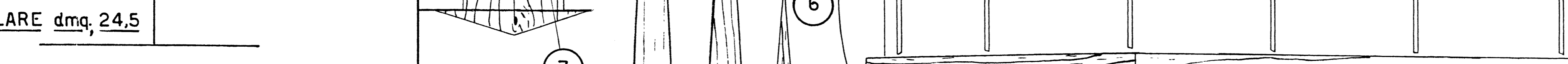
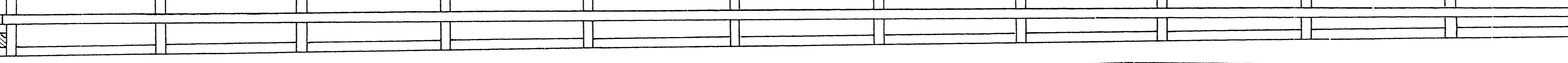
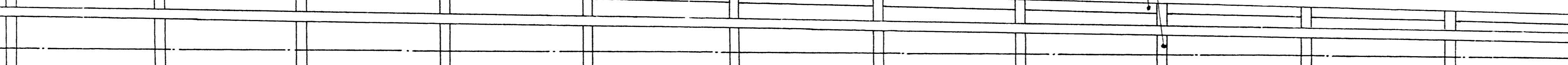
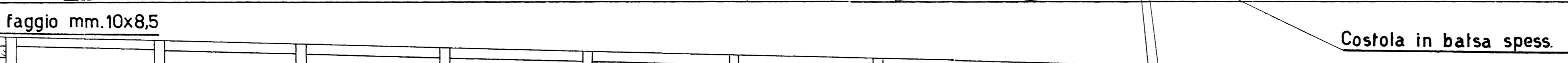
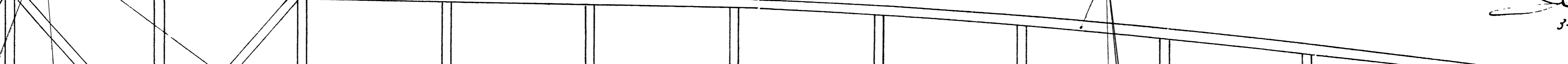
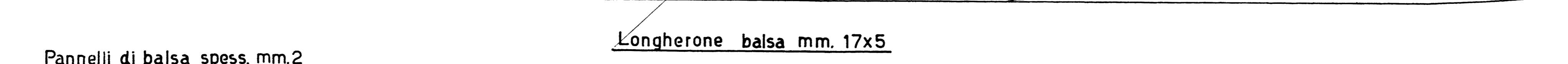
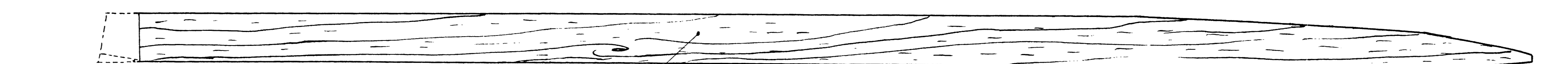
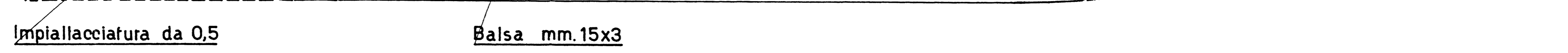
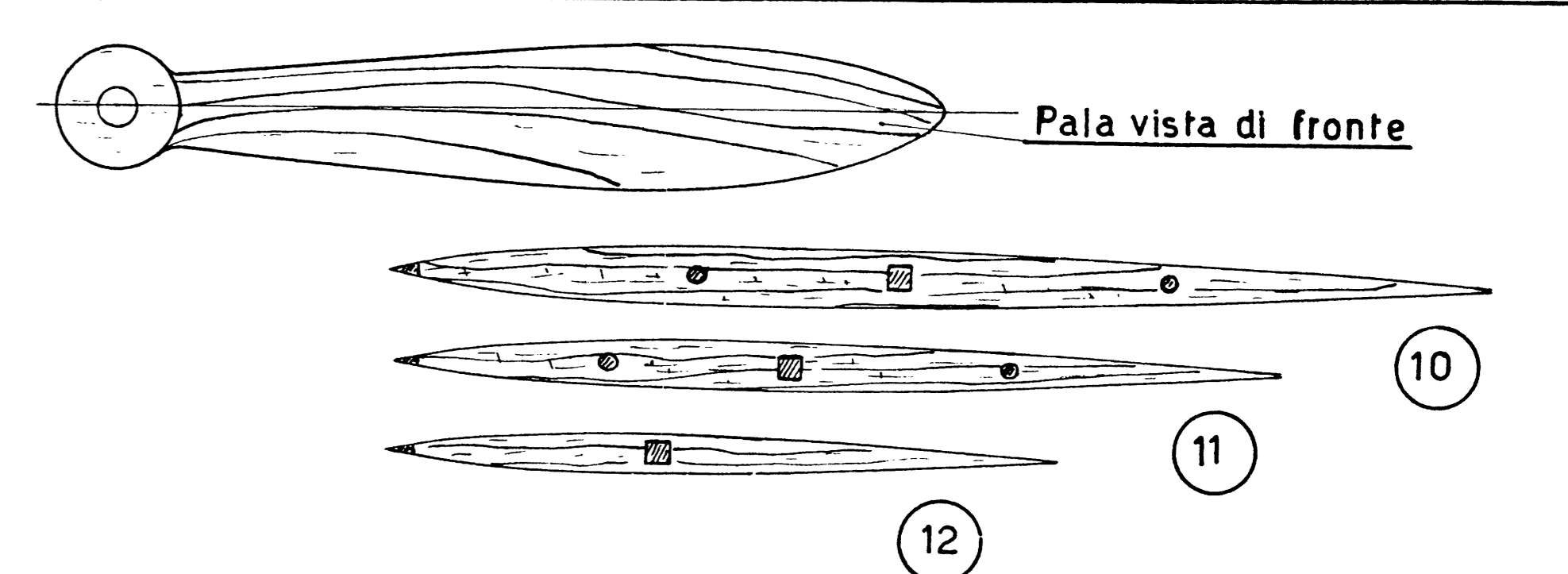

CARATTERISTICHE DEL "MERCURIO"	
APERTURA mm. 1000	PESO gr. 450
LUNGHEZZA mm 1040	SUPERF. STAB. dmq. 9
SUPERF. ALARE dmq. 24,5	
Vincitore Eliminatorie Provinciali di ROMA 1943-t. 2'46"	
Vincitore 19 Campionato Romano 1943-t.comples. 5'21"	
59 Class.9 Concorso Nazionale di FIRENZE 1943-t. 1'53"	

DISEGNATO DA: *Castellani*  
3-11-1943 - Cremona

